

OPTIM STONE

AMÉNAGEMENT EXTÉRIEUR



CATALOGUE

INDEX

• Graviers décoratifs	
- Standard	3
- Premium	8
• Gabions décoratifs	38
• Accessoires	42
• Ardoises et pierres	47
• Boules et galets décoratifs	52
• Figures décoratives	55

Bienvenue dans le monde d'Optim Béton

Optim Béton. Qui sommes-nous?

Une société créée en 2010, par l'ajout de plusieurs entreprises partenaires qui ont un long voyage et une expérience dans l'industrie de la construction. L'entreprise vise à la commercialisation en gros d'un large éventail de produits pour la construction et la décoration. Plus précisément, nous avons structuré notre gamme de produits en 6 familles: Optim Build, Optim Ceram, Optim Green, Optim Sands, Optim Stone, Optim Pools.

Contrôle de qualité et processus

Toujours en avance sur les besoins de la clientèle pour offrir les plus de qualité, de sécurité et de fiabilité.

-Contrôle de la qualité à l'origine par le personnel expert et rigoureux d'Optim Béton.

-Travail, innovation sur les packagings et les réglementations en vigueur.

-Equipe logistique experte qui suit tout le processus pour toujours plus de rapidité et de fiabilité.

-Traçabilité et suivi du produit depuis la carrière d'origine jusqu'au client final.

Priorité: le service client et sa satisfaction

Nous sommes une équipe d'experts dans les domaines des mortiers, bétons et la pierre naturelle, qui a le souci de fournir à notre clientèle des produits sûrs et un service de qualité.

Notre expérience dans les projets de différentes envergures, nous permet de donner des conseils de qualités à nos clients, en fournissant une valeur ajoutée au produit et en garantissant une pleine satisfaction.

Notre engagement vers un environnement plus sûr.

Maîtriser les impacts sur l'environnement aux par l'adoption de bonnes pratiques industrielles sur tous nos sites, et toujours à la recherche d'innovation. Ces bonnes pratiques s'inspirent des résultats des études menées avec une nécessité de première importance, et tournées vers le besoin de l'équilibre naturel et en respectant notre environnement pour le respect des futures générations.

Se soumettre à des contrôles de qualités régulièrement et attendre des objectifs déterminés dans un plan d'action de pérennité.

Des formations et des actions de sensibilisation pour améliorer les pratiques et les connaissances relatives à notre environnement naturel.

SYMBOLOLOGIE



Vrac



Filet



Sac



Big Bag



Roller



Palette



Boîte



Unité



Gabion

Photos non contractuelles.

Veillez à toujours suivre les informations figurant sur l'étiquette du produit.

OPTIM **STONE**

GRAVIERS DÉCORATIFS
STANDARD



**CALCAIRE**

5/12

CONCASSÉ STANDARD

Code	EAN Code	Format	Poids	Un./pal.
V-CCB5-12	ND	VRAC	-	-
F-20CCB5-12	8436564424907	FILET	20 Kg	66
S-25CCB5-12	8437011742988	SAC	25 Kg	54
BB-05CCB5-12	8437011742995	BIG BAG	500 Kg	2 (a)
BB-1CCB5-12	8436550660005	BIG BAG	1000 Kg	1

(a) Commande par multiple de 2 de la même référence



Filet



Sac



Big Bag



Vrac

CALCAIRE

12/25

CONCASSÉ STANDARD

Code	EAN Code	Format	Poids	Un./pal.
V-CCB12-25	ND	VRAC	-	66
F-20CCB12-25	8436564424914	SAC	25 Kg	54
S-25CCB12-25	8436550660029	BIG BAG	500 Kg	2 (a)
BB-05CCB12-25	8436550660036	BIG BAG	1000 Kg	1
BB-1CCB12-25	8436550660043	ROLLER	1000 Kg	1

(a) Commande par multiple de 2 de la même référence



Filet



Sac



Big Bag



Vrac

**BLANC PYRÉNÉES**

6/10

CONCASSÉ STANDARD

Code	EAN Code	Format	Poids	Un./pal.
V-CBLPY6-10	ND	VRAC	-	66
F-20CBLPY6-10	8436588673602	FILET	20 Kg	54
S-25CBLPY6-10	8436588673619	SAC	25 Kg	2 (a)
BB-05CBLPY6-10	8436588673626	BIG BAG	500 Kg	1
BB-1CBLPY6-10	8436588673633	BIG BAG	1000 Kg	1

(a) Commande par multiple de 2 de la même référence



Filet



Sac



Big Bag



Vrac



BLANC 6/13

CONCASSÉ STANDARD

Code	EAN Code	Format	Poids	Un./pal.
V-CBLANC6-13	ND	VRAC	-	-
F-20CBLANC6-13	8436564426352	FILET	20 Kg	66
S-25CBLANC6-13	8436564424839	SAC	25 Kg	54
BB-05CBLANC6-13	8436564424846	BIG BAG	500 Kg	2 (a)
BB-1CBLANC6-13	8436564424853	BIG BAG	1000 Kg	1

(a) Commande par multiple de 2 de la même référence



BLANC 10/20

CONCASSÉ STANDARD

Code	EAN Code	Format	Poids	Un./pal.
V-CBLANC10-20	ND	VRAC	-	-
F-20CBLANC10-20	8436564424860	FILET	20 Kg	66
S-25CBLANC10-20	8436564424877	SAC	25 Kg	54
BB-05CBLANC10-20	8436564424884	BIG BAG	500 Kg	2 (a)
BB-1CBLANC10-20	8436564424891	BIG BAG	1000 Kg	1

(a) Commande par multiple de 2 de la même référence



**GRIS PYRÉNÉES**

4/12

CONCASSÉ STANDARD

Code	EAN Code	Format	Poids	Un./pal.
V-CGPY4-12	ND	VRAC	-	-
F-20CGPY4-12	8436564424990	FILET	20 Kg	66
S-25CGPY4-12	8436564425003	SAC	25 Kg	54
BB-05CGPY4-12	8436564425010	BIG BAG	500 Kg	2 (a)
BB-1CGPY4-12	8436564425027	BIG BAG	1000 Kg	1

(a) Commande par multiple de 2 de la même référence



Filet



Sac



Big Bag



Vrac

SAUMON PYRÉNÉES

8/18

CONCASSÉ STANDARD

Code	EAN Code	Format	Poids	Un./pal.
V-CSPY8-18	ND	VRAC	-	-
F-20CSPY8-18	8436588673640	FILET	20 Kg	66
S-25CSPY8-18	8436588673657	SAC	25 Kg	54
BB-05CSPY8-18	8436588673664	BIG BAG	500 Kg	2 (a)
BB-1CSPY8-18	8436588673671	BIG BAG	1000 Kg	1

(a) Commande par multiple de 2 de la même référence



Filet



Sac



Big Bag



Vrac

GALET DE RIVIÈRE

8/16

GALET STANDARD

Code	EAN Code	Format	Poids	Un./pal.
V-GDR8-16	ND	VRAC	-	-
F-20GDR8-16	8436564425065	FILET	20 Kg	66
S-25GDR8-16	8436550666601	SAC	25 Kg	54
BB-05GDR8-16	8436550663785	BIG BAG	500 Kg	2 (a)
BB-1GDR8-16	8436550663792	BIG BAG	1000 Kg	1

(a) Commande par multiple de 2 de la même référence



Filet



Sac



Big Bag



Vrac

GALET DE RIVIÈRE

16/22

GALET STANDARD

Code	EAN Code	Format	Poids	Un./pal.
V-GDR16-22	ND	VRAC	-	-
F-20GDR16-22	8436564425089	FILET	20 Kg	66
S-25GDR16-22	8436550663808	SAC	25 Kg	54
BB-1GDR16-22	8436550663822	BIG BAG	1000 Kg	1



Filet



Sac



Big Bag



Vrac



GALET DE RIVIÈRE

20/40

GALET STANDARD

Code	EAN Code	Format	Poids	Un./pal.
V-GDR20-40	ND	VRAC	-	-
F-20GDR20-40	8436564425096	FILET	20 Kg	66
S-25GDR20-40	8436550663297	SAC	25 Kg	54
BB-1GDR20-40	8436550663846	BIG BAG	1000 Kg	1



Filet



Sac



Big Bag



Vrac

OPTIM STONE

GRAVIERS DÉCORATIFS PREMIUM



BLANC SPÉCIAL

8/12

CONCASSÉ PREMIUM

Code	EAN Code	Format	Poids	Un./pal.
V-CBS8-12	ND	VRAC	-	-
F-20CBS8-12	8436564421708	FILET	20 Kg	66
S-25CBS8-12	8436550660173	SAC	25 Kg	54
BB-05CBS8-12	8436550660180	BIG BAG	500 Kg	2 (a)
BB-1CBS8-12	8436550660197	BIG BAG	1000 Kg	1
R-10CBS8-12	8436564422811	ROLLER	1000 Kg	1

(a) Commande par multiple de 2 de la même référence



Filet



Sac



Big Bag



Vrac



Roller



BLANC SPÉCIAL 12/18

CONCASSÉ PREMIUM

Code	EAN Code	Format	Poids	Un./pal.
V-CBS12-18	ND	VRAC	-	-
F-20CBS12-18	8436564421715	FILET	20 Kg	66
S-25CBS12-18	8436550660210	SAC	25 Kg	54
BB-05CBS12-18	8436550660227	BIG BAG	500 Kg	2 (a)
BB-1CBS12-18	8436550660234	BIG BAG	1000 Kg	1
R-10CBS12-18	8436564426505	ROLLER	1000 Kg	1

(a) Commande par multiple de 2 de la même référence



Filet



Sac



Big Bag



Vrac



Roller

BLANC SPÉCIAL 20/40

CONCASSÉ PREMIUM

Code	EAN Code	Format	Poids	Un./pal.
V-CBS20-40	ND	VRAC	-	-
F-20CBS20-40	8436564425034	FILET	20 Kg	66
S-25CBS20-40	8436564425041	SAC	25 Kg	54
BB-05CBS20-40	8436564425058	BIG BAG	500 Kg	2 (a)
BB-1CBS20-40	8436564421593	BIG BAG	1000 Kg	1
R-10CBS20-40	8436564426512	ROLLER	1000 Kg	1

(a) Commande par multiple de 2 de la même référence



Filet



Sac



Big Bag



Vrac



Roller



BLANC SPÉCIAL 40/60

CONCASSÉ PREMIUM

Code	EAN Code	Format	Poids	Un./pal.
V-CBS40-60	ND	VRAC	-	-
F-20CBS40-60	8436564426475	FILET	20 Kg	66
S-25CBS40-60	8436564426482	SAC	25 Kg	54
BB-05CBS40-60	8436564426499	BIG BAG	500 Kg	2 (a)
BB-1CBS40-60	8436564424495	BIG BAG	1000 Kg	1
R-10CBS40-60	8436564426529	ROLLER	1000 Kg	1

(a) Commande par multiple de 2 de la même référence



Filet



Sac



Big Bag



Vrac



Roller

**GRIS BLEU DE TURQUIN****8/12**

CONCASSÉ PREMIUM

Code	EAN Code	Format	Poids	Un./pal.
V-CGB8-12	ND	VRAC	-	-
F-20CGB8-12	8436564421722	FILET	20 Kg	66
S-25CGB8-12	8436550663334	SAC	25 Kg	54
BB-05CGB8-12	8436550668919	BIG BAG	500 Kg	2 (a)
BB-1CGB8-12	8436550668926	BIG BAG	1000 Kg	1
R-10CGB8-12	8436564426543	ROLLER	1000 Kg	1

(a) Commande par multiple de 2 de la même référence



Filet



Sac



Big Bag



Vrac



Roller

GRIS BLEU DE TURQUIN**12/18**

CONCASSÉ PREMIUM

Code	EAN Code	Format	Poids	Un./pal.
V-CGB12-18	ND	VRAC	-	-
F-20CGB12-18	8436564421739	FILET	20 Kg	66
S-25CGB12-18	8436564420718	SAC	25 Kg	54
BB-05CGB12-18	8436564420725	BIG BAG	500 Kg	2 (a)
BB-1CGB12-18	8436564420411	BIG BAG	1000 Kg	1
R-10CGB12-18	8436564427519	ROLLER	1000 Kg	1

(a) Commande par multiple de 2 de la même référence



Filet



Sac



Big Bag



Vrac



Roller





NOIR PREMIUM 6/10

CONCASSÉ PREMIUM

Code	EAN Code	Format	Poids	Un./pal.
V-CNPREM6-10	ND	VRAC	-	-
S-25CNPREM6-10	8436564425423	SAC	20 Kg	54
BB-05CNPREM6-10	8436564425416	BIG BAG	500 Kg	2 (a)
BB-1CNPREM6-10	8436564425409	BIG BAG	1000 Kg	1
R-10CNPREM6-10	8436564426659	ROLLER	1000 Kg	1

(a) Commande par multiple de 2 de la même référence



Roller



Filet



Sac



Big Bag



Vrac

NOIR PREMIUM 10/14

CONCASSÉ PREMIUM

Code	EAN Code	Format	Poids	Un./pal.
V-CNPREM10-14	ND	VRAC	-	-
F-20CNPREM10-14	8436564426383	FILET	20 Kg	66
S-25CNPREM10-14	8436564426376	FILET	20 Kg	66
BB-05CNPREM10-14	8436564425447	SAC	25 Kg	54
BB-1CNPREM10-14	8436564425430	BIG BAG	500 Kg	2 (a)
R-10CNPREM10-14	8436564426666	BIG BAG	1000 Kg	1

(a) Commande par multiple de 2 de la même référence



Filet



Sac



Big Bag



Vrac



Roller

**BLANC & NOIR**

8/20

CONCASSÉ PREMIUM

Code	EAN Code	Format	Poids	Un./pal.
F-20CBNB8-20	8436588673060	FILET	20 Kg	66
S-25CBNB8-20	8436588673053	SAC	25 Kg	54
BB-1CBNB8-20	8436588673039	BIG BAG	1000 Kg	1



Filet



Sac



Big Bag

MULTICOLORE

8/16

CONCASSÉ PREMIUM

Code	EAN Code	Format	Poids	Un./pal.
F-20CM8-16	8436564421852	FILET	20 Kg	66
S-25CM8-16	8436550663341	SAC	25 Kg	54
BB-1CM8-16	8436550663327	BIG BAG	1000 Kg	1
R-10CM8-16	8436550669558	ROLLER	1000 Kg	1



Filet



Sac



Big Bag



Roller

**MULTICOLORE**

12/22

CONCASSÉ PREMIUM

Code	EAN Code	Format	Poids	Un./pal.
F-20CM12-22	8436564421869	FILET	20 Kg	66
S-25CM12-22	8436550664331	SAC	25 Kg	54
BB-1CM12-22	8436550664355	BIG BAG	1000 Kg	1



Filet



Sac



Big Bag



ROUGE CORAIL 6/10

CONCASSÉ PREMIUM

Code	EAN Code	Format	Poids	Un./pal.
V-CRC6-10	ND	VRAC	-	-
F-20CRC6-10	8436564428646	FILET	20 Kg	66
S-25CRC6-10	8436550663303	SAC	25 Kg	54
BB-05CRC6-10	8436550664607	BIG BAG	500 Kg	2 (a)
BB-1CRC6-10	8436550664614	BIG BAG	1000 Kg	1

(a) Commande par multiple de 2 de la même référence



ROUGE CORAIL 9/20

CONCASSÉ PREMIUM

Code	EAN Code	Format	Poids	Un./pal.
V-CRC9-20	ND	VRAC	-	-
F-20CRC9-20	8436564421968	FILET	20 Kg	66
S-25CRC9-20	8436564421975	SAC	25 Kg	54
BB-05CRC9-20	8436564421982	BIG BAG	500 Kg	2 (a)
BB-1CRC9-20	8436564421999	BIG BAG	1000 Kg	1
R-10CRC9-20	8436564426550	ROLLER	1000 Kg	1

(a) Commande par multiple de 2 de la même référence



**ROSÉ VALENCIA****6/10**

CONCASSÉ PREMIUM

Code	EAN Code	Format	Poids	Un./pal.
V-CRV6-10	ND	VRAC	-	-
F-20CRV6-10	8436564428431	FILET	20 Kg	66
S-25CRV6-10	8436550660548	SAC	25 Kg	54
BB-05CRV6-10	8436550660555	BIG BAG	500 Kg	2 (a)
BB-1CRV6-10	8437011742810	BIG BAG	1000 Kg	1
R-10CRV6-10	8436564426567	ROLLER	1000 Kg	1

(a) Commande par multiple de 2 de la même référence



Filet



Sac



Big Bag



Vrac



Roller

ROSÉ VALENCIA**10/15**

CONCASSÉ PREMIUM

Code	EAN Code	Format	Poids	Un./pal.
V-CRV10-15	ND	VRAC	-	-
F-20CRV10-15	8436564422170	FILET	20 Kg	66
S-25CRV10-15	8437011742612	SAC	25 Kg	54
BB-05CRV10-15	8436550660579	BIG BAG	500 Kg	2 (a)
BB-1CRV10-15	8436550660586	BIG BAG	1000 Kg	1
R-10CRV10-15	8436564421616	ROLLER	1000 Kg	1

(a) Commande par multiple de 2 de la même référence



Filet



Sac



Big Bag



Vrac



Roller





ARDOISE NOIRE 6/40

CONCASSÉ PREMIUM

Code	EAN Code	Format	Poids	Un./pal.
F-18CA6-40	8436550669961	FILET	18 L	54
S-18CA6-40	8436550669978	SAC	18 L	54
BB-12CA6-40	8436588672193	BIG BAG	1200 Kg	1



Filet



Sac



Big Bag

ARDOISE NOIRE 20/40

CONCASSÉ PREMIUM

Code	EAN Code	Format	Poids	Un./pal.
F-18CA20-40	8436564425119	FILET	18 L	54
S-18CA20-40	8436564425126	SAC	18 L	54
BB-1CA20-40	8436564425140	BIG BAG	1000 Kg	1
R-10CA20-40	8436564426581	ROLLER	1000 Kg	1



Filet



Sac



Big Bag



Roller



**BRIQUE PILÉE**

5/18

CONCASSÉ PREMIUM

Code	EAN Code	Format	Poids	Un./pal.
V-CBP5-18	ND	VRAC	-	-
F-18CBP5-18	8436564420213	FILET	18 L	54
S-18CBP5-18	8436564420220	SAC	18 L	54
BB-05CBP5-18	8436550662924	BIG BAG	500 L	2 (a)
BB-1CBP5-18	8436550662931	BIG BAG	1000 L	1
R-10CBP5-18	8436564426598	ROLLER	1000 L	1

(a) Commande par multiple de 2 de la même référence



Filet



Sac



Big Bag



Vrac



Roller

BRIQUE PILÉE

18/35

CONCASSÉ PREMIUM

Code	EAN Code	Format	Poids	Un./pal.
V-CBP18-35	ND	VRAC	-	-
F-18CBP18-35	8436564420237	FILET	18 L	54
S-18CBP18-35	8436564420244	SAC	18 L	54
BB-05CBP18-35	8436550662955	BIG BAG	500 L	2 (a)
BB-1CBP18-35	8436550662962	BIG BAG	1000 L	1
R-10CBP18-35	8436564426604	ROLLER	1000 L	1

(a) Commande par multiple de 2 de la même référence



Filet



Sac



Big Bag



Vrac



Roller



POUZZOLANE 7/12

CONCASSÉ PREMIUM

Code	EAN Code	Format	Poids	Un./pal.
V-CP7-12	ND	VRAC	-	-
F-18CP7-12	8436550662825	FILET	18 L	54
S-18CP7-12	8436564420008	SAC	18 L	54
BB-05CP7-12	8436550665390	BIG BAG	500 L	2 (a)
BB-1CP7-12	8436550665406	BIG BAG	1000 L	1
R-10CP7-12	8436564426611	ROLLER	1000 L	1

(a) Commande par multiple de 2 de la même référence



POUZZOLANE 15/25

CONCASSÉ PREMIUM

Code	EAN Code	Format	Poids	Un./pal.
V-CP15-25	ND	VRAC	-	-
F-18CP15-25	8436564420015	FILET	18 L	54
S-18CP15-25	8436564420022	SAC	18 L	54
BB-05CP15-25	8436550665437	BIG BAG	500 L	2 (a)
BB-1CP15-25	8436550665444	BIG BAG	1000 L	1
R-10CP15-25	8436564426628	ROLLER	1000 L	1

(a) Commande par multiple de 2 de la même référence



POUZZOLANE 25/50

CONCASSÉ PREMIUM

Code	EAN Code	Format	Poids	Un./pal.
V-CP25-50	ND	VRAC	-	-
F-18CP25-50	8436564420039	FILET	18 L	54
S-18CP25-50	8436564420046	SAC	18 L	54
BB-05CP25-50	8436550665475	BIG BAG	500 L	2 (a)
BB-1CP25-50	8436550665482	BIG BAG	1000 L	1
R-10CP25-50	8436564426635	ROLLER	1000 L	1

(a) Commande par multiple de 2 de la même référence



**BLANC MARBRE DE CARRARE****12/18**

GALET PREMIUM

Code	EAN Code	Format	Poids	Un./pal.
V-GBMC12-18	ND	VRAC	-	-
F-20GBMC12-18	8436564425157	FILET	20 Kg	66
S-25GBMC12-18	8436564425164	SAC	25 Kg	54
BB-05GBMC12-18	8436564425171	BIG BAG	500 Kg	2 (a)
BB-1GBMC12-18	8436564425188	BIG BAG	1000 Kg	1
R-10GBMC12-18	8436564428349	ROLLER	1000 Kg	1

(a) Commande par multiple de 2 de la même référence



Filet



Sac



Big Bag



Vrac



Roller

BLANC MARBRE DE CARRARE**20/40**

GALET PREMIUM

Code	EAN Code	Format	Poids	Un./pal.
V-GBMC20-40	ND	VRAC	-	-
F-20GBMC20-40	8436564425195	FILET	20 Kg	66
S-25GBMC20-40	8436564425201	SAC	25 Kg	54
BB-05GBMC20-40	8436564425218	BIG BAG	500 Kg	2 (a)
BB-1GBMC20-40	8436564425225	BIG BAG	1000 Kg	1
R-10GBMC20-40	8436564428332	ROLLER	1000 Kg	1

(a) Commande par multiple de 2 de la même référence



Filet



Sac



Big Bag



Vrac



Roller

**BLANC MARBRE DE CARRARE****40/60**

GALET PREMIUM

Code	EAN Code	Format	Poids	Un./pal.
V-GBMC40-60	ND	VRAC	-	-
F-20GBMC40-60	8436564425232	BIG BAG	20 Kg	66
S-25GBMC40-60	8436564425249	SAC	25 Kg	54
BB-05GBMC40-60	8436564425256	BIG BAG	500 Kg	2 (a)
BB-1GBMC40-60	8436564425263	BIG BAG	1000 Kg	1
R-10GBMC40-60	8436564428356	ROLLER	1000 Kg	1

(a) Commande par multiple de 2 de la même référence



Filet



Sac



Big Bag



Vrac



Roller



BLANC MACAEL 100/150

GALET PREMIUM

Code	EAN Code	Format	Poids	Un./pal.
R-10GBM100-150 *	8436564425270	ROLLER	±1500 Kg	1

(*) Sur demande



Roller

BLANC MACAEL 150/300

GALET PREMIUM

Code	EAN Code	Format	Poids	Un./pal.
R-10GBM150-300 *	8436550669572	ROLLER	±1500 Kg	1

(*) Sur demande



Roller



**BLANC SPÉCIAL****10/20**

GALET PREMIUM

Code	EAN Code	Format	Poids	Un./pal.
V-GBS10-20	ND	VRAC	-	-
F-20GBS10-20	8436564422217	FILET	20 Kg	66
S-25GBS10-20	8436550660982	SAC	25 Kg	54
BB-05GBS10-20	8436550660999	BIG BAG	500 Kg	2 (a)
BB-1GBS10-20	8436550661002	BIG BAG	1000 Kg	1
R-10GBS10-20	8436550669527	ROLLER	1000 Kg	1

(a) Commande par multiple de 2 de la même référence



Filet



Sac



Big Bag



Vrac



Roller

BLANC SPÉCIAL**20/40**

GALET PREMIUM

Code	EAN Code	Format	Poids	Un./pal.
V-GBS20-40	ND	VRAC	-	-
F-20GBS20-40	8436564422231	FILET	20 Kg	66
F-10GBS20-40	8436564428516	FILET	10 Kg	135
S-25GBS20-40	8436550661026	SAC	25 Kg	54
S-10GBS20-40	8436588672520	SAC	10 Kg	140
BB-05GBS20-40	8436550661033	BIG BAG	500 Kg	2 (a)
BB-1GBS20-40	8436550661040	BIG BAG	1000 Kg	1
R-10GBS20-40	8436564424457	ROLLER	1000 Kg	1

(a) Commande par multiple de 2 de la même référence



Filet



Sac



Big Bag



Vrac



Roller

**BLANC SPÉCIAL****40/60**

GALET PREMIUM

Code	EAN Code	Format	Poids	Un./pal.
V-GBS40-60	ND	VRAC	-	-
F-20GBS40-60	8436564420626	FILET	20 Kg	66
S-25GBS40-60	8436550661064	SAC	25 Kg	54
BB-05GBS40-60	8436550661071	BIG BAG	500 Kg	2 (a)
BB-1GBS40-60	8436550661088	BIG BAG	1000 Kg	1
R-10GBS40-60	8436550669534	ROLLER	1000 Kg	1

(a) Commande par multiple de 2 de la même référence



Filet



Sac



Big Bag



Vrac



Roller





BLANC SPÉCIAL 60/120

GALET PREMIUM

Code	EAN Code	Format	Poids	Un./pal.
V-GBS60-120	ND	VRAC	-	-
F-20GBS60-120	8436564422248	FILET	20 Kg	66
BB-05GBS60-120	8436550661118	BIG BAG	500 Kg	2 (a)
BB-1GBS60-120	8436550661125	BIG BAG	1000 Kg	1
R-10GBS60-120	8436564420480	ROLLER	1000 Kg	1

(a) Commande par multiple de 2 de la même référence



ANATOLIA NOIR 40/60

GALET PREMIUM

Code	EAN Code	Format	Poids	Un./pal.
F-18CP15-25	8436564420015	FILET	20 Kg	54
BB-1CP15-25	8436550665444	BIG BAG	1000 Kg	1



ANATOLIA NOIR 60/100

GALET PREMIUM

Code	EAN Code	Format	Poids	Un./pal.
F-18CP15-25	8436564420015	FILET	20 Kg	66
BB-1CP15-25	8436550665444	BIG BAG	1000 Kg	1





GRIS BLEU DE TURQUIN

8/12

GALET PREMIUM

Code	EAN Code	Format	Poids	Un./pal.
F-20GGB8-12	8436564422309	FILET	20 Kg	66
S-25GGB8-12	8436550665611	SAC	25 Kg	54
BB-1GGB8-12	8436550665635	BIG BAG	1000 Kg	1
R-10GGB8-12	8436564423290	ROLLER	1000 Kg	1



Filet



Sac



Big Bag



Roller

GRIS BLEU DE TURQUIN

12/24

GALET PREMIUM

Code	EAN Code	Format	Poids	Un./pal.
F-20GGB12-24	8436588672889	FILET	20 Kg	66
S-25GGB12-24	8436588672902	SAC	25 Kg	54
BB-05GGB12-24	8436588672926	BIG BAG	500 Kg	2 (a)
BB-1GGB12-24	8436588672896	BIG BAG	1000 Kg	1
R-10GGB12-24	8436588672919	ROLLER	1000 Kg	1

(a) Commande par multiple de 2 de la même référence



Filet



Sac



Big Bag



Roller



GRIS BLEU DE TURQUIN

24/40

GALET PREMIUM

Code	EAN Code	Format	Poids	Un./pal.
F-20GGB24-40	8436588672971	FILET	20 Kg	66
S-25GGB24-40	8436588672964	SAC	25 Kg	54
BB-05GGB24-40	8436588672940	BIG BAG	500 Kg	2 (a)
BB-1GGB24-40	8436588672933	BIG BAG	1000 Kg	1
R-10GGB24-40	8436588672957	ROLLER	1000 Kg	1

(a) Commande par multiple de 2 de la même référence



Filet



Sac



Big Bag



Roller



GRIS BLEU DE TURQUIN 40/60

GALET PREMIUM

Code	EAN Code	Format	Poids	Un./pal.
F-20GGB40-60	8436588673091	FILET	20 Kg	66
S-25GGB40-60	8436588673107	SAC	25 Kg	54
BB-1GGB40-60	8436588673084	BIG BAG	1000 Kg	1
R-10GGB40-60	8436588673114	ROLLER	1000 Kg	1



Filet



Sac



Big Bag



Roller

GRIS BLEU DE TURQUIN 60/100

60/100

GALET PREMIUM

Code	EAN Code	Format	Poids	Un./pal.
F-20GGB60-100	8436588673022	FILET	20 Kg	66
BB-1GGB60-100	8436588672988	BIG BAG	1000 Kg	1
R-10GGB60-100	8436588673008	ROLLER	1000 Kg	1



Filet



Big Bag



Roller



**NOIR****12/24**

GALET PREMIUM

Code	EAN Code	Format	Poids	Un./pal.
F-20GNOIR12-24	8436564425287	FILET	20 Kg	66
S-25GNOIR12-24	8436564425294	SAC	25 Kg	54
BB-05GNOIR12-24	8436564425300	BIG BAG	500 Kg	2 (a)
BB-1GNOIR12-24	8436564425317	BIG BAG	1000 Kg	1
R-10GNOIR12-24	ND	ROLLER	1000 Kg	1

(a) Commande par multiple de 2 de la même référence



Filet



Sac



Big Bag



Roller

NOIR**24/40**

GALET PREMIUM

Code	EAN Code	Format	Poids	Un./pal.
F-20GNOIR24-40	8436564425324	FILET	20 Kg	66
S-25GNOIR24-40	8436564425331	SAC	25 Kg	54
BB-05GNOIR24-40	8436564425348	BIG BAG	500 Kg	2 (a)
BB-1GNOIR24-40	8436564425355	BIG BAG	1000 Kg	1
R-10GNOIR24-40	ND	ROLLER	1000 Kg	1

(a) Commande par multiple de 2 de la même référence



Filet



Sac



Big Bag



Roller

**NOIR****40/60**

GALET PREMIUM

Code	EAN Code	Format	Poids	Un./pal.
F-20GNOIR40-60	8436564425362	FILET	20 Kg	66
S-25GNOIR40-60	8436564425379	SAC	25 Kg	54
BB-1GNOIR40-60	8436564425485	BIG BAG	1000 Kg	1
R-10GNOIR40-60	ND	ROLLER	1000 Kg	1



Filet



Sac



Big Bag



Roller



NOIR POLI 15/25

GALET PREMIUM

Code	EAN Code	Format	Poids	Un./pal.
F-20GNP15-25	8436564429520	FILET	20 Kg	66
F-10GNP15-25	8436564429513	FILET	10 Kg	135



Filet

NOIR POLI 30/50

GALET PREMIUM

Code	EAN Code	Format	Poids	Un./pal.
F-20GNP30-50	8436564427137	FILET	20 Kg	66
F-10GNP30-50	8436564427113	FILET	10 Kg	135
BB-1GNP30-50	8436564427199	BIG BAG	1000 Kg	1



Filet



Big Bag



**MULTICOLORE****8/12**

GALET PREMIUM

Code	EAN Code	Format	Poids	Un./pal.
F-20GPM8-12	8436564422460	FILET	20 Kg	66
S-25GPM8-12	8437011742193	SAC	25 Kg	54
BB-1GPM8-12	8436550662399	BIG BAG	1000 Kg	1
R-10GPM8-12	8436564420527	ROLLER	1000 Kg	1



Filet



Sac



Big Bag



Roller

MULTICOLORE**12/18**

GALET PREMIUM

Code	EAN Code	Format	Poids	Un./pal.
F-20GPM12-18	8436564422477	FILET	20 Kg	66
S-25GPM12-18	8437011742735	SAC	25 Kg	54
BB-1GPM12-18	8436550662429	BIG BAG	1000 Kg	1
R-10GPM12-18	8436564427151	ROLLER	1000 Kg	1



Filet



Sac



Big Bag



Roller

**MULTICOLORE****20/30**

GALET PREMIUM

Code	EAN Code	Format	Poids	Un./pal.
F-20GPM20-30	8436564422484	FILET	20 Kg	66
S-25GPM20-30	8437011742636	SAC	25 Kg	54
BB-1GPM20-30	8436550662450	BIG BAG	1000 Kg	1
R-10GPM20-30	8436588672346	ROLLER	1000 Kg	1



Filet



Sac



Big Bag



Roller



MULTICOLORE 30/60

GALET PREMIUM

Code	EAN Code	Format	Poids	Un./pal.
F-20GPM30-60	8436564422491	FILET	20 Kg	66
S-25GPM30-60	8437011742698	SAC	25 Kg	54
BB-1GPM30-60	8436550662481	BIG BAG	1000 Kg	1
R-10GPM30-60	8436588672353	ROLLER	1000 Kg	1



Filet



Sac



Big Bag



Roller



**TRICOLORE**

8/12

GALET PREMIUM

Code	EAN Code	Format	Poids	Un./pal.
F-20GT8-12	8436564428653	FILET	20 Kg	66
S-25GT8-12	8436564428660	SAC	25 Kg	54
BB-1GT8-12	8436564428684	BIG BAG	1000 Kg	1
R-10GT8-12	8436564428691	ROLLER	1000 Kg	1



Filet



Sac



Big Bag



Roller

TRICOLORE

12/18

GALET PREMIUM

Code	EAN Code	Format	Poids	Un./pal.
F-20GT12-18	8436564428707	FILET	20 Kg	66
S-25GT12-18	8436564428714	SAC	25 Kg	54
BB-1GT12-18	8436564428738	BIG BAG	1000 Kg	1
R-10GT12-18	8436564428745	ROLLER	1000 Kg	1



Filet



Sac



Big Bag



Roller

**TRICOLORE**

20/30

GALET PREMIUM

Code	EAN Code	Format	Poids	Un./pal.
F-20GT20-30	8436564428752	FILET	20 Kg	66
S-25GT20-30	8436564428769	SAC	25 Kg	54
BB-1GT20-30	8436564428783	BIG BAG	1000 Kg	1
R-10GT20-30	8436564428790	ROLLER	1000 Kg	1



Filet



Sac



Big Bag



Roller



TRICOLORE 30/60

GALET PREMIUM

Code	EAN Code	Format	Poids	Un./pal.
F-20GT30-60	8436564428806	FILET	20 Kg	66
S-25GT30-60	8436564428813	SAC	25 Kg	54
BB-1GT30-60	8436564428837	BIG BAG	1000 Kg	1
R-10GT30-60	8436564428844	ROLLER	1000 Kg	1



Filet



Sac



Big Bag



Roller



**ROUGE CORAIL****12/18**

GALET PREMIUM

Code	EAN Code	Format	Poids	Un./pal.
F-20GRC12-18	8436564422576	FILET	20 Kg	66
S-25GRC12-18	8437011742728	SAC	25 Kg	54
BB-1GRC12-18	8437011742506	BIG BAG	1000 Kg	1
R-10GRC12-18	ND	ROLLER	1000 Kg	1



Filet



Sac



Big Bag



Roller

ROUGE CORAIL**20/30**

GALET PREMIUM

Code	EAN Code	Format	Poids	Un./pal.
F-20GRC20-30	8436564422583	FILET	20 Kg	66
S-25GRC20-30	8437011742322	SAC	25 Kg	54
BB-1GRC20-30	8436550662009	BIG BAG	1000 Kg	1
R-10GRC20-30	8436588672681	ROLLER	1000 Kg	1

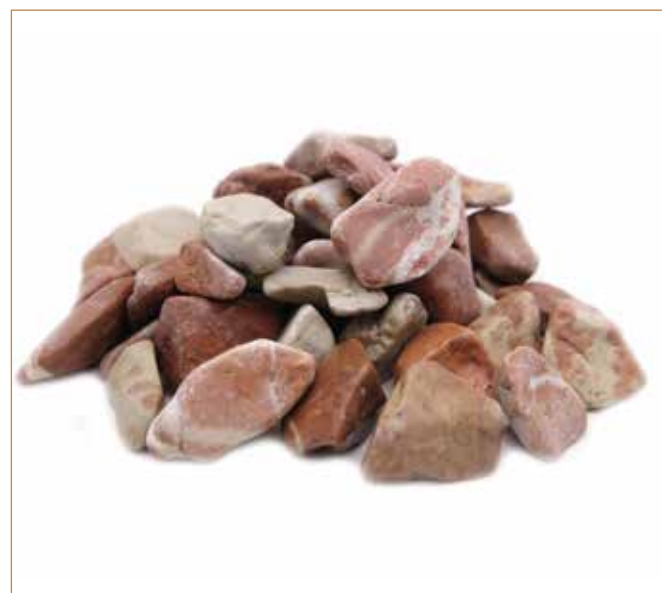

Filet



Sac



Big Bag



Roller

**ROUGE CORAIL****30/60**

GALET PREMIUM

Code	EAN Code	Format	Poids	Un./pal.
F-20GRC30-60	8436564422590	FILET	20 Kg	66
S-25GRC30-60	8437011742551	SAC	25 Kg	54
BB-1GRC30-60	8436550662030	BIG BAG	1000 Kg	1
R-10GRC30-60	8436588672698	ROLLER	1000 Kg	1



Filet



Sac



Big Bag



Roller



ROUGE CORAIL **70/120**

GALET PREMIUM

Code	EAN Code	Format	Poids	Un./pal.
F-20GRC70-120	8436564422613	FILET	20 Kg	66
BB-1GRC70-120	8436550666052	BIG BAG	1000 Kg	1
R-10GRC70-120	8436564420602	ROLLER	1000 Kg	1



Filet



Big Bag



Roller



**JAUNE****12/18**

GALET PREMIUM

Code	EAN Code	Format	Poids	Un./pal.
BB-1GJ12-18	8436550662139	BIG BAG	1000 Kg	1
R-10GJ12-18	ND	ROLLER	1000 Kg	1



Big Bag



Roller

JAUNE**20/30**

GALET PREMIUM

Code	EAN Code	Format	Poids	Un./pal.
F-20GJ20-30	8436564422644	FILET	20 Kg	66
S-25GJ20-30	8437011742377	SAC	25 Kg	54
BB-1GJ20-30	8436550662160	BIG BAG	1000 Kg	1
R-10GJ20-30	ND	ROLLER	1000 Kg	1



Filet



Sac



Big Bag



Roller

**JAUNE****30/60**

GALET PREMIUM

Code	EAN Code	Format	Poids	Un./pal.
BB-1GJ30-60	8436550662207	BIG BAG	1000 Kg	1
R-10GJ30-60	8436550669503	ROLLER	1000 Kg	1



Big Bag



Roller





RAINBOW 40/60

GALET PREMIUM

Code	EAN Code	Format	Poids	Un./pal.
F-20GRAIN40-60	8436588671257	FILET	20 Kg	66



Filet

RAINBOW 60/100

GALET PREMIUM

Code	EAN Code	Format	Poids	Un./pal.
F-20GRAIN60-100	8436588671271	FILET	20 Kg	66



Filet



RAINBOW 200/300

GALET PREMIUM

Code	EAN Code	Format	Poids	Un./pal.
BB-13GRAIN200-300	8436588671288	BIG BAG	1000 Kg	1



Big Bag

**ROSÉ VALENCIA**

8/12

GALET PREMIUM

Code	EAN Code	Format	Poids	Un./pal.
F-20GPRV8-12	8436564422682	FILET	20 Kg	66
S-25GPRV8-12	8437011742186	SAC	25 Kg	54
BB-1GPRV8-12	8436550661866	BIG BAG	1000 Kg	1
R-10GPRV8-12	8436550669497	ROLLER	1000 Kg	1



Filet



Sac



Big Bag



Roller

ROSÉ VALENCIA

12/24

GALET PREMIUM

Code	EAN Code	Format	Poids	Un./pal.
F-20GPRV12-24	8436588673442	FILET	20 Kg	66
S-25GPRV12-24	8436588673466	SAC	25 Kg	54
BB-1GPRV12-24	8436588673435	BIG BAG	1000 Kg	1
R-10GPRV12-24	8436588673541	ROLLER	1000 Kg	1



Filet



Sac



Big Bag



Roller

**ROSÉ VALENCIA**

24/40

GALET PREMIUM

Code	EAN Code	Format	Poids	Un./pal.
F-20GPRV24-40	8436588673497	FILET	20 Kg	66
S-25GPRV24-40	8436588673503	SAC	25 Kg	54
BB-1GPRV24-40	8436588673480	BIG BAG	1000 Kg	1
R-10GPRV24-40	8436588673558	ROLLER	1000 Kg	1



Filet



Sac



Big Bag



Roller



ROSÉ VALENCIA 40/60

GALET PREMIUM

Code	EAN Code	Format	Poids	Un./pal.
F-20GPRV40-60	8436588673534	FILET	20 Kg	66
S-25GPRV40-60	8436588673800	SAC	25 Kg	54
BB-1GPRV40-60	8436588673527	BIG BAG	1000 Kg	1



Filet



Sac



Big Bag

ARDOISE NOIRE 20/40

GALET PREMIUM

Code	EAN Code	Format	Poids	Un./pal.
F-18GAN20-40	8436564422934	FILET	20 L	66
S-18GAN20-40	8436564422941	SAC	25 L	54
BB-1GAN20-40	8436564422965	BIG BAG	1000 Kg	1
R-10GAN20-40	ND	ROLLER	1000 Kg	1



Filet



Sac



Big Bag



Roller



ARDOISE NOIRE 40/60

GALET PREMIUM

Code	EAN Code	Format	Poids	Un./pal.
F-18GAN40-60	8436564422972	FILET	20 L	66
S-18GAN40-60	8436564422989	SAC	25 L	54
BB-1GAN40-60	8436564423009	BIG BAG	1000 Kg	1
R-10GAN40-60	8436564423399	ROLLER	1000 Kg	1



Filet



Sac



Big Bag



Roller

**TRAVERTIN JAUNE****40/60***GALET PREMIUM*

Code	EAN Code	Format	Poids	Un./pal.
F-20GTRAV40-60	8436588672001	FILET	20 Kg	66
BB-1GTRAV40-60	8436588672025	BIG BAG	1000 Kg	1



Filet



Big Bag

TRAVERTIN JAUNE**60/100***GALET PREMIUM*

Code	EAN Code	Format	Poids	Un./pal.
F-20GTRAV60-100	8436588672018	FILET	20 Kg	66
BB-1GTRAV60-100	8436588672032	BIG BAG	1000 Kg	1



Filet



Big Bag



DE RIVIÈRE GRILLÉ 6/12

GALET PREMIUM

Code	EAN Code	Format	Poids	Un./pal.
F-20GDRG6-12	8436588671943	FILET	20 Kg	66
S-25GDRG6-12	8436588671929	SAC	25 Kg	54
BB-1GDRG6-12	8436588671967	BIG BAG	1000 Kg	1



Filet



Sac



Big Bag

DE RIVIÈRE GRILLÉ 24/40

GALET PREMIUM

Code	EAN Code	Format	Poids	Un./pal.
F-20GDRG24-40	8436588671950	FILET	20 Kg	66
S-25GDRG24-40	8436588671936	SAC	25 Kg	54
BB-1GDRG24-40	8436588671974	BIG BAG	1000 Kg	1



Filet



Sac



Big Bag

OPTIM **STONE**

GABIONS DÉCORATIFS

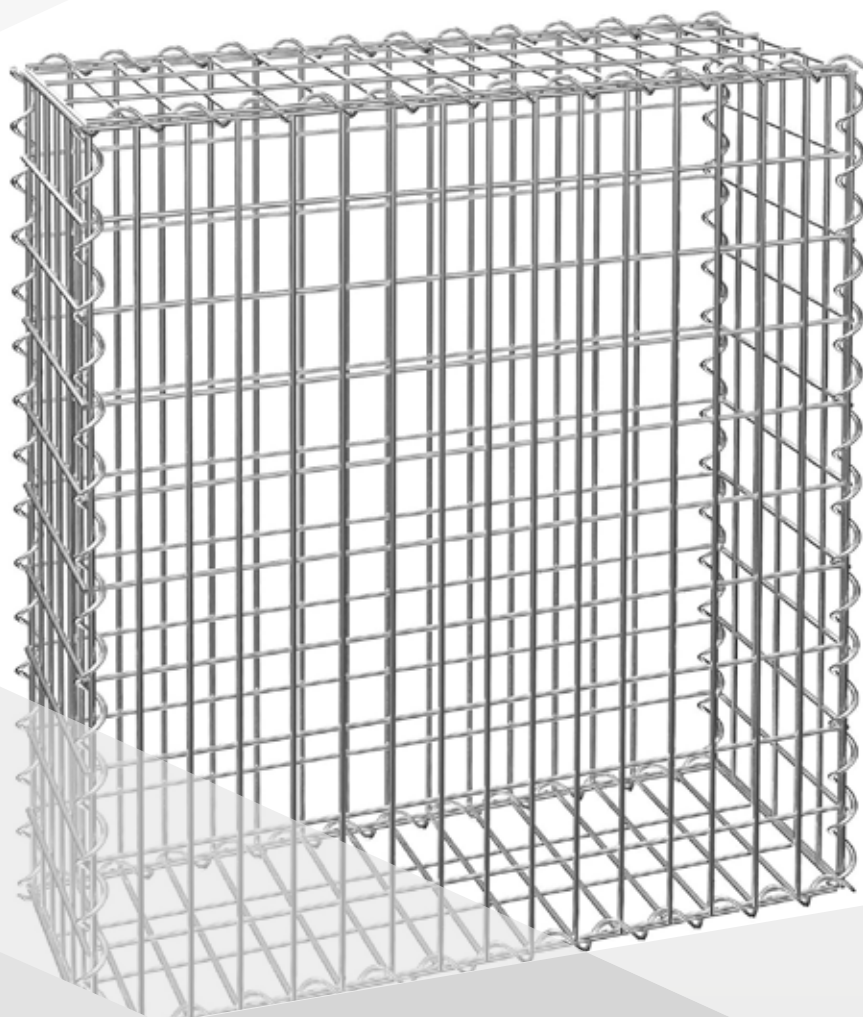

GABIONS DÉCORATIFS

Code	EAN Code	Longueur(L)x Largeur(W)x Hauteur(H)	Poids	Poids (*)
GD4-50X50X50	8436550668872	50X50X50 cm	7.50 Kg	200 Kg
GD4-100X30X30	8436550668834	100X30X30 cm	7.20 Kg	144 Kg
GD4-100X50X50	8436550668889	100X50X50 cm	12.20 Kg	400 Kg
GD4-200X30X30	8436550668841	200X30X30 cm	13.70 Kg	288 Kg
GD4-200X50X50	8436550668896	200X50X50 cm	22.70 Kg	800 Kg
GD4-200X50X100	8436550668902	200X50X100 cm	34.30 Kg	1600 Kg

Treillis métallique en acier de Ø 4 mm. Fenêtre 50x50 mm.
 (*) Poids approximatif basé sur une pierre basaltique
USAGE DÉCORATIF - NON STRUCTUREL



Gabion

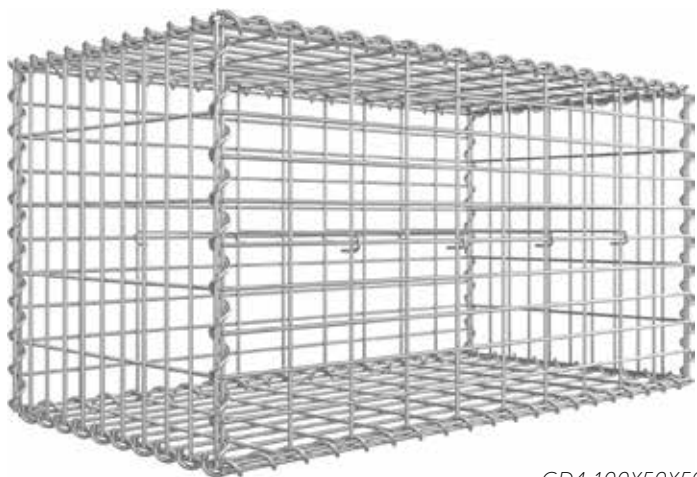

GD4-100X50X50

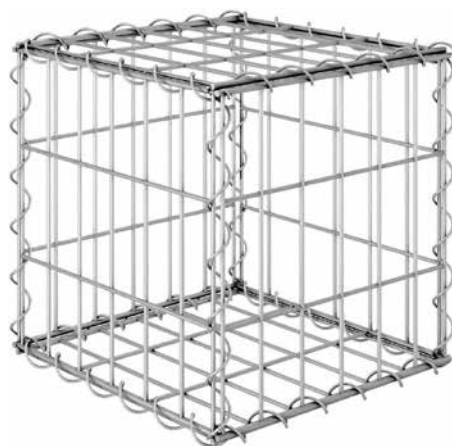

GD4-50X50X50

Les gabions sont des structures (prismes rectangulaires) composées de panneaux de grillage électrosoudés rigides, drainants, monolithiques et faciles à installer.

Constitué de 3 éléments : le panneau, la spirale et le renfort.

Les cages métalliques offrent divers avantages esthétiques et fonctionnels.

Type de maille : Conformément à la norme BS EN 10223-4:1998 pour les clôtures soudées.

Fil & Résistance à la traction : 450 – 575 N/mm² et tous conformes à la norme BS EN 10218-2.

Espacement de maille : 50 x 50 mm conformément à ASTM 974 - 97

Diamètre du fil de treillis : Fil galvanisé à chaud de haute qualité 4,0 mm

Revêtement de fil : >275 grammes, Galvanisé à chaud de haute résistance conforme à la norme BSEN10224-2:2001 Tableau 1, Classe A.

Tolérances : Conforme à ASTM 974-97.

Résistance au cisaillement du pot de soudage : >3800Mpa.

Diamètre des spirales et des espaces : 4.0 mm, >275grams.

Rejoins par des Spirales : Pas = 50 mm, Diamètre extérieur = 23 mm.

Dimensions du panneau : 30x30, 50x50, 50x100, 50x200, 100x200 cm.

Taille des mailles : 50x50 mm.

Dimensions des gabions (longueur x largeur x hauteur) :

50x50x50 cm ; 100x30x30 ; 100x50x50 cm ; 200x50x50 cm ; 200x50x100 cm ; 200x30x30 cm.

Granulométrie conseillée des matériaux de remplissage : 60 à 200 mm.

Assemblage : au moyen de spirales ou d'agrafes.

Les gabions offrent de nombreuses possibilités de remplissage :

pierres et agrégats de tous types, céramiques, rondins, dalles de pierre, galets ronds, etc...

En plus d'être utilisés pour limiter les zones du jardin et pour construire de petits murs afin d'empêcher la migration de la terre (pas des murs structurels), ils offrent également la possibilité de construire du mobilier d'extérieur : bancs, barbecues, etc...

ASSEMBLAGE / MONTAGE GABION

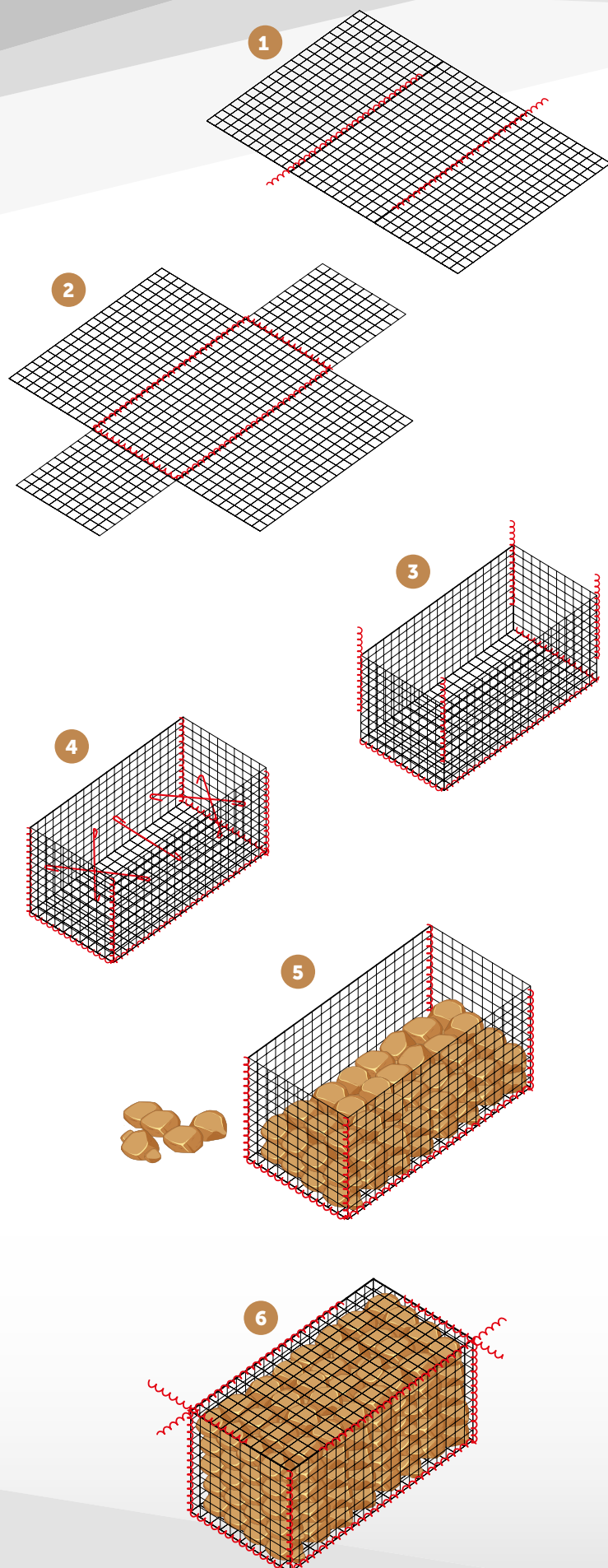

1- Poser au sol le panneau de fond et les deux panneaux latéraux. Lier les trois panneaux (panneau de sol + panneaux latéraux) à l'aide des spirales correspondant à la longueur des panneaux (si nécessaire, couper en deux les grandes spirales et les faire accéder des deux côtés).

Tourner les spirales en vissant (sens horaire) : la spirale se positionne naturellement pour former une liaison.
Pour des raisons esthétiques, il est préférable de disposer les fils verticaux des panneaux vers l'extérieur.

2- Sur le même principe d'assemblage, procéder à la liaison des autres panneaux à l'aide des spirales correspondantes. L'assemblage de la forme du gabion est alors réalisé.

3- Relever les côtés individuellement et lier successivement les panneaux avec les spirales de la bonne dimension. S'assurer que les spirales sont montées correctement, de manière à former une liaison rigide sans espace entre les panneaux. Optim Béton fournit des spirales correspondant aux dimensions des panneaux. De plus, pour garantir la qualité et la rigidité, l'ensemble des éléments du gabion est conçu avec la même épaisseur de fil galvanisé traité haute protection.

4- Disposer les raidisseurs en reliant la face avant et la face arrière. Pour assurer la parfaite tenue du gabion, les renforts doivent être positionnés après un premier niveau de pierres d'environ 20 cm à partir du bas du gabion.

5- Pour le remplissage, utiliser des pierres non gélives et non friables, de granulométrie comprise entre 60 et 150 mm. Disposer les pierres par couches successives et régulières, en protégeant les raidisseurs qui pourraient se déformer au détriment de l'esthétique et de la qualité de la réalisation.

6- Relever les côtés individuellement et lier successivement les panneaux avec les spirales adaptées. S'assurer que les spirales sont montées correctement afin de former une liaison rigide sans espace entre les panneaux. Le gabion est déjà monté.



Photos non contractuelles

PIERRES SPÉCIFIQUES POUR REMPLISSAGE DE GABIONS

Code	EAN Code	Description	Granul.	Format	Poids	Un./pal.
BB-1CG60-120 (*)	8436550663754	Concassé STANDARD Granit	60-120 mm	BIG BAG	1000 Kg	1
BB-1CBN50-120 (*)	8436564429049	Concassé STANDARD Basalt Noir	50-120 mm	BIG BAG	1000 Kg	1
BB-1GDR60-80 (*)	8436588673787	Galet STANDARD De Rivière	60-80 mm	BIG BAG	1000 Kg	1

(*) Sur demande



OPTIM STONE

ACCESSOIRES

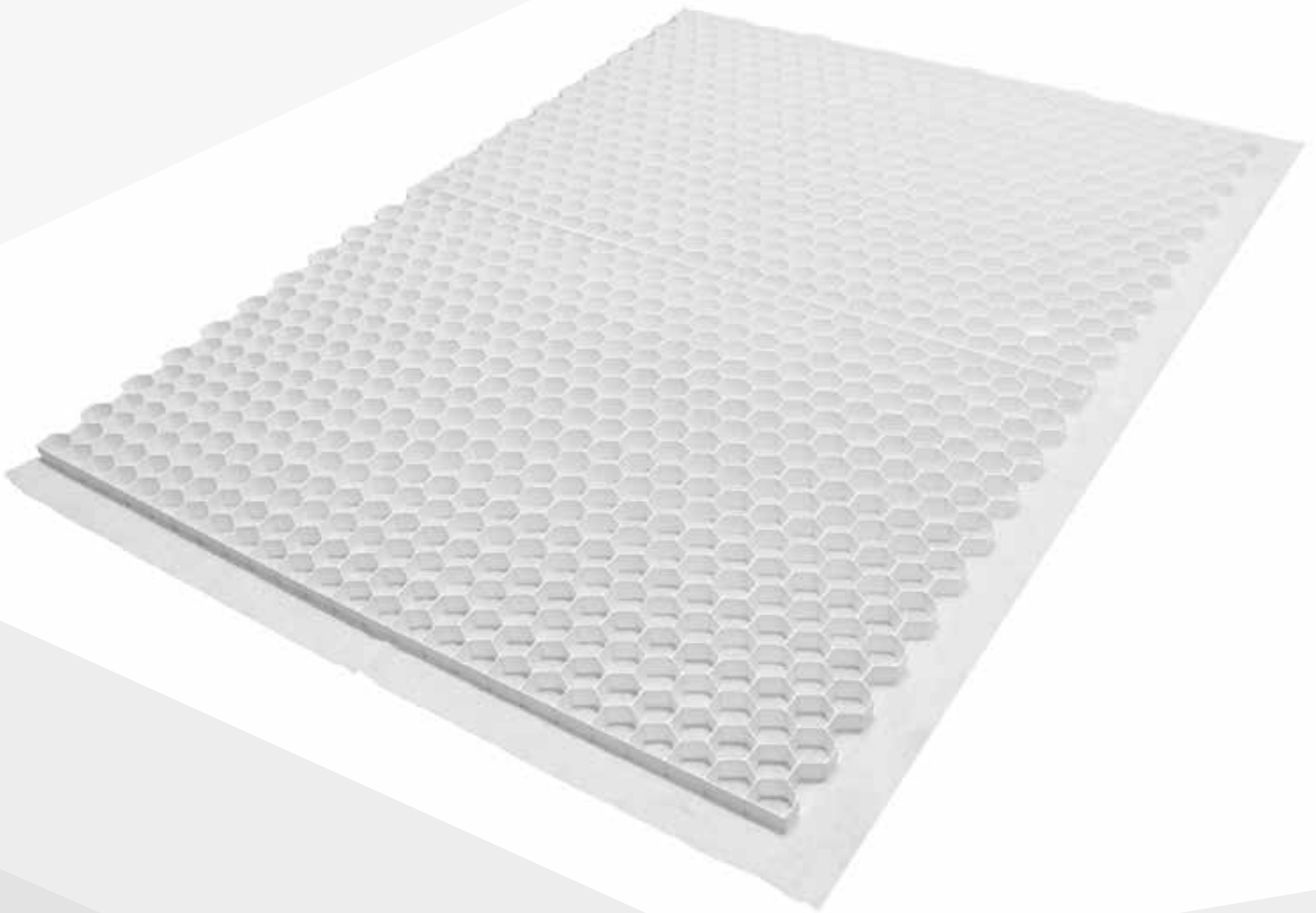

DALLE STABILISATRICE 129

Code	Ean Code	Un./palette	Poids/palette	m ² /palette	Un. Min. Vente
DS-129B	3614200000004	37	53 Kg	35.52	Palette

Mesures de la plaque : 1200 x 800 x 29 mm (0.96 m²)



Palette

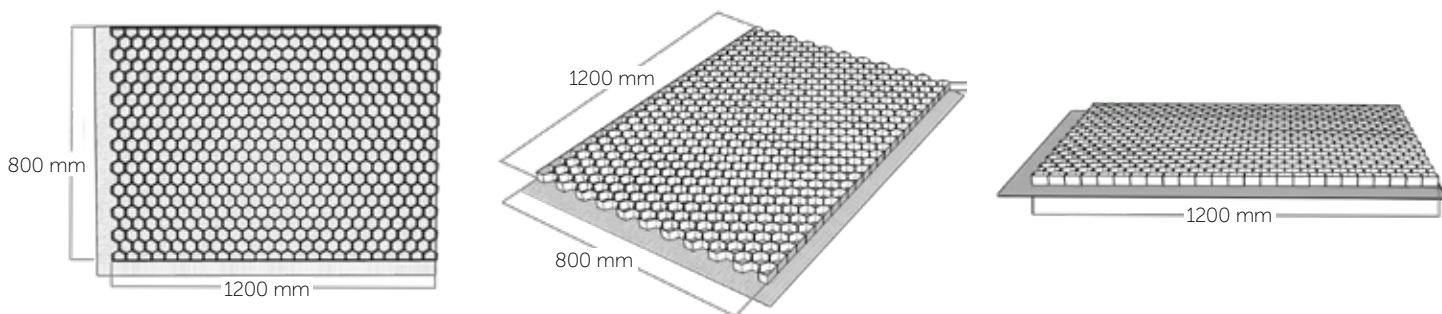

DESCRIPTION

Dalle Stabilisatrice 129 : une alternative aux revêtements traditionnels. Le gravier donne une impression d'espace et permet de marier minéral et végétal. Il est idéal pour réaliser des allées, des accès de garage, des terrasses, etc. Utiliser un gravier de type concassé, lavé, non friable de granulométrie jusqu'à 15 mm. Coucher de recouvrement : 1 à 2 cm d'épaisseur au-dessus de la plaque.
 Avec les plaques Dalle Stabilisatrice 129, chaque revêtement de graviers devient beaucoup plus praticable que dans le passé. La structure alvéolaire des plaques permet, en effet, de maintenir le gravier parfaitement en place. Leurs dimensions vous garantissent une pose rapide et facile.
 Se promener, rouler à vélo, se déplacer en fauteuil roulant ou conduire la poussette de votre enfant ne pose plus le moindre problème. Sols meubles, ornières disgracieuses, flaques d'eau gênantes et nids-depoule dangereux ne sont plus qu'un mauvais souvenir.

PRODUIT	DALLE STABILISATRICE 129
Dimensions (Longueur x Largeur (mm))	1200 X 800 mm
Epaisseur	29 mm
Taille des alvéoles	± 50 mm
Résistance en compression recouvert de graviers **	Jusqu'à à 400 t/m ²
Couleurs	blanc
Matière structure nid d'abeille	PP et anti U.V. haute performance
Matière géotextile	PET 45 g/m ²
Masse surfacique	1,20 kg/m ²

** Varie en fonction de la nature du matériau de remplissage



CONDITIONNEMENT	
Pièces / Palette	37
M ² / Palette	35,52
Poids Palette (Kg)	53
Hauteur Palette (mm)	1223
Dimensions conditionnement	L: 1200 mm x l: 800 mm
Description conditionnement	Housse de protection, Cerclage, Cornière marketing



SÉPARATEUR CURVE PVC

Code	Ean Code	Un./palette	Ud/paquet	Kg/paquet	ml/paquet	Un. Min. Vente
SP-CUPVC50HT	5413945042779	Profil Separateur Curve PVC 50 HT	20	17	40	Paquet

Mesures : 2000 x 100 x 50 mm - Matériel inclus : 50 clous et 20 raccords en H

DESCRIPTION

Le SÉPARATEUR CURVE PVC est une bordure souple et légère idéale pour structurer des courbes dans vos aménagements extérieurs. Fabriqué en plastique PVC (aspect gris), il permet de délimiter facilement les massifs, parterres ou chemins, tout en s'adaptant aux formes naturelles du sol. Son installation est rapide après stabilisation du terrain.

CARACTÉRISTIQUES TECHNIQUES :

Matériau : PVC **Aspect :** Gris **Forme :** Flexible (idéale pour les courbes)
Utilisation : Courbes ou droites **Installation :** Rapide, légère, à poser sur sol stabilisé



Boîte

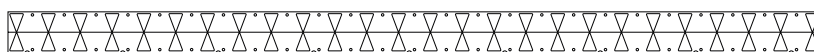
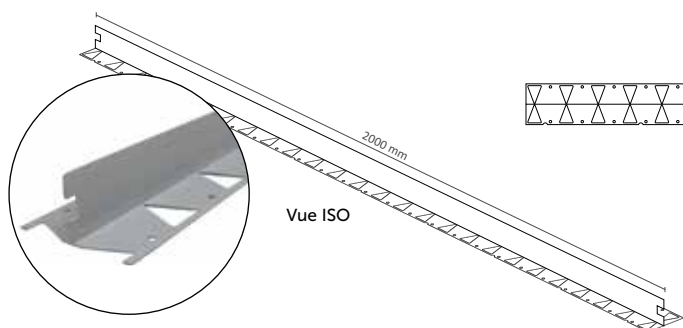

Vue de dessus

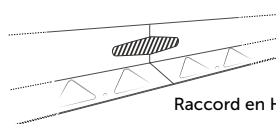

Raccord en H

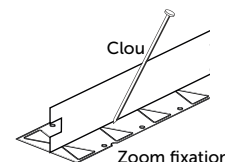

Zoom fixation

SÉPARATEUR GALVA ÉQUERRE

Code	Ean Code	Description	Ud/ paquet	Kg/paquet	ml/paquet	Un. Min. Vente
SP-GALVEQ80	8436564425720	Galva Equerre 80	5	14,60	9,50	Paquet

Mesures : 1900 x 80 x 50 mm - Matériel inclus : 20 pieux d'ancrage.

DESCRIPTION

Le SÉPARATEUR GALVA ÉQUERRE est une bordure métallique en tôle d'acier galvanisée (aspect gris brillant) conçue pour délimiter efficacement les espaces extérieurs : massifs, allées, contours d'arbres ou parterres. Léger, maniable et robuste, il s'adapte aussi bien aux projets privés que professionnels. Son installation est simple et rapide, sans outils complexes.

CARACTÉRISTIQUES TECHNIQUES :

Matériau : Acier galvanisé **Aspect :** Gris brillant **Forme :** Équerre
Utilisation : Droite ou légèrement courbée **Installation :** Manuelle, rapide, sans entretien



Boîte



Vue de dessus

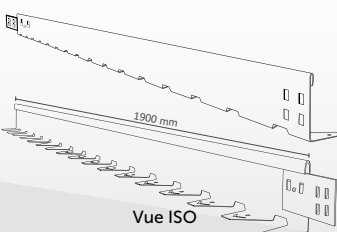

Vue ISO



Pieu d'ancrage 200 mm

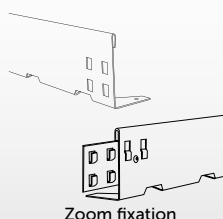

Zoom fixation



BORDURE VULCANO NOIR

Code	EAN Code	Poids	Un. Min. Vente	Format
SP-VULCANO140X10	8054085311119	11,5 KG	Unité	Rouleau

Remarque: les piquets sont vendu séparément



Boîte

DESCRIPTION

Fabriquées exclusivement à partir de HDPE recyclé à 100%, ces pièces allient élasticité et rigidité. La surface est délibérément finie de manière rugueuse pour créer un effet brut, similaire à celui de la pierre. Par conséquent, les variations d'apparence, les irrégularités de surface et les fluctuations de dimensions ne doivent pas être perçues comme des défauts, mais plutôt comme des caractéristiques distinctives du produit.

CARACTÉRISTIQUES TECHNIQUES :

Aspect : Noire Longueur: 10 m. Hauteur: 140 mm. Épaisseur: 8 mm.

PIQUETS DE BORDURE DE LIGNE VULCANO

Code	Ean Code	Un. Min. Vente
SP-PICBORF5NR	8054085311263	Sac 5 unités



Boîte

STABILISATEUR GRAVIERS

Code	Ean Code	Un./palette	Format	Poids	Un. Min. Vente
CGD-PGLUE01	5060778150012	Stabilisateur Gravier Monocomponent	Recipient 1 L.	1 Kg	Unité
CGD-PGLUE05	5060778150005	Stabilisateur Gravier Monocomponent	Recipient 5 L.	5 Kg	Unité

DESCRIPTION

Optim Glue est un liant adhésif à base d'eau, facile à utiliser, conçu pour maintenir solidement en place les pierres décoratives, l'écorce, le paillis, les graviers et autres matériaux, en évitant leur déplacement ou leur désordre dans vos aménagements paysagers.



OPTIM **STONE**

ARDOISES ET PIERRES



MARCHES ET CLÔTURES EN ARDOISE

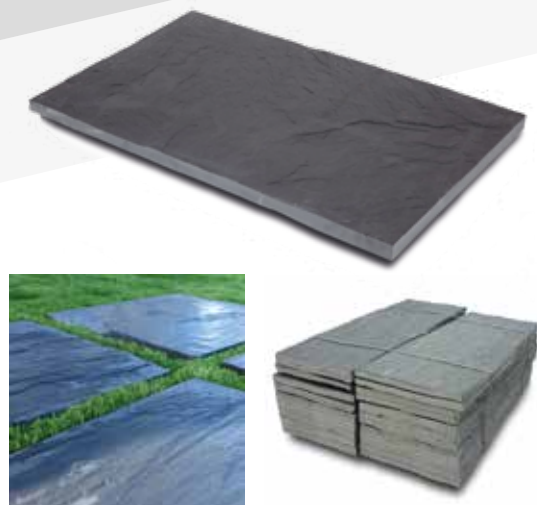

Code	Ean Code	Mesures	Poids/Un. (Approx.)	Un./Palette (Approx.)	Un. Min. De Vente
PA-40X30	8436588671059	40x30x3 cm	10 Kg	100	Unité
PA-60X30	8436564423443	60x30x2 cm	15 Kg	100	Unité
PA-50X50	8436564423436	50x50x3 cm	16,5 Kg	70	Unité
PA-100X30	8436564423450	100x30x3 cm	25 Kg	40	Unité
PA-100X50	8436564423467	100x50x3 cm	37 Kg	31	Unité
PA-200X30	8436564423474	200x30x3 cm	53 Kg	40	Unité
PA-100X10X3	8436588673374	100x10x3 cm	8,65 Kg	120	Unité

Tolérance +/- 1 cm.



BARRETTES DE SCHISTE

Code	Ean Code	Mesures	Poids/Un. (Approx.)	Un./Palette (Approx.)	Un. Min. De Vente
BA-050	8436588672087	50 cm	9 Kg	200	Unité
BA-100	8436564423481	100 cm	16 Kg	100	Unité
BA-150	8436564423498	150 cm	20 Kg	80	Unité
BA-200	8436564423504	200 cm	61,3 Kg	62	Unité
BA-100P	8436588673381	100x10x6 cm	6,91 Kg	60	Unité

Section carrée des pièces : entre 3 et 7 cm.



MARCHES ET CLÔTURES PIERRE MORISCA



Code	Ean Code	Mesures	Poids/Un. (Approx.)	Un./Palette (Approx.)	Un. Min. De Vente
PM-40X30	8436588671585	40x30x3 cm	10 Kg	80	Unité
PM-60X30	8436588671745	60x30x3 cm	15 Kg	110	Unité
PM-100X30	8436588671578	100x30x3 cm	25 Kg	54	Unité

Tolérance +/- 1 cm

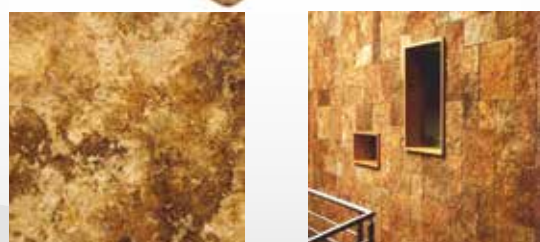

MONOLITHE D'ARDOISE

Code	Ean Code	Mesures	Poids/Un. (Approx.)	Un./Palette (Approx.)	Un. Min. De Vente
MOA-120	8436564423542	50-100 cm	30-60 Kg	30-35 un.	Unité

Pièces avec un côté irrégulier et ou dentelé. () Sur demande*



PAS JAPONAIS

Code	Ean Code	Mesures	Poids/Un. (Approx.)	Un./Palette (Approx.)	Un. Min. De Vente
PJ-30	8436564424433	Ø 30 cm	3.50 Kg	200	Unité
PJ-40	8436564423627	Ø 40 cm	5 Kg	145	Unité
PJ-50	8436564423634	Ø 50 cm	9 Kg	104	Unité

() Sur demande*

Code	Ean Code	Mesures	Poids/Un. (Approx.)	Un./Palette (Approx.)	Un. Min. De Vente
PJ-00	8436564423696	Irrégulière	± 1500 Kg	25m ²	Palette

() Sur demande*



PALIS D'ARDOISE AVEC TROUS

Code	Ean Code	Mesures	Poids/Un. (Approx.)	Un./Palette (Approx.)	Un. Min. De Vente
PALA-TROUS15	8436564423665	150x50x3 cm	63.75 Kg	24	Unité
PALA-TROUS20	8436564423672	200x50x3 cm	85.00 Kg	24	Unité

() Sur demande*



PIERRES DE PAREMENT TAILLÉES



Code	Ean Code	Mesures	Poids/Un. (Approx.)	Un./Palette (Approx.)	Un. Min. De Vente
PEL-100X35X07	8436564423702	100x35x07 cm	± 1470 Kg	20	Unité
PEL-100X35X15	8436564423719	100x35x15 cm	± 1470 Kg	10	Unité

*Materiel sans calibrer ni dans l'épaisseur ni dans la dimension.
Front Naturel / 3 côtés scies. (*) Sur demande*



Unité



Palette

MONOLITHE QUARZITHE

Code	Ean Code	Mesures	Poids/Un. (Approx.)	Un./Palette (Approx.)	Un. Min. De Vente
MOQ-120	8436564423573	50-120 Cm	30-60 Kg	Unité	Unité

() Sur demande*



Unité



OPTIM STONE

BOULES ET GALETS DÉCORATIFS



GRANIT GRIS NATUREL

Code	Ean Code	Mesures Ø cm	Poids/Un. (Approx.)	Un. Min. De Vente
BD-02GRGR	8436564426109	20	12 Kg	Unité
BD-03GRGR	8436564426680	30	38 Kg	Unité
BD-04GRGR	8436564426697	40	90 Kg	Unité

(*) Sur demande



Unité



MARBRE GRIS POLI

Code	Ean Code	Mesures Ø cm	Poids/Un. (Approx.)	Un. Min. De Vente
BD-02MRGR	8436564426703	20	12 Kg	Unité
BD-03MRGR	8436564426710	30	38 Kg	Unité
BD-04MRGR	8436564426727	40	90 Kg	Unité

(*) Sur demande



Unité

GRANIT NOIR

Code	Ean Code	Mesures Ø cm	Poids/Un. (Approx.)	Un. Min. De Vente
BD-02GRNE	8436564426741	20	12 Kg	Unité
BD-03GRNE	8436564426758	30	38 Kg	Unité
BD-04GRNE	8436564426765	40	90 Kg	Unité

(*) Sur demande



Unité



RAINBOW

Code	Ean Code	Mesures Ø cm	Poids/Un. (Approx.)	Un. Min. De Vente
BD-02RNBO	8436564426796	20	12 Kg	Unité
BD-03RNBO	8436564426802	30	35 Kg	Unité
BD-04RNBO	8436564426819	40	90 Kg	Unité

(*) Sur demande



GALETS DÉCORATIFS



Code	Ean Code	Description	Poids/Un. (Approx.)	Un. Min. De Vente
BP-BLANC35X25	8436588673688	Amande Blanc	20 Kg	Unité
BP-RIVIERA35X25	8436588673695	Amande Riviera	20 Kg	Unité
BP-BORDO35X25	8436588673701	Amande Bordo	20 Kg	Unité
BP-NOIR35X25	8436588673718	Amande Noir	20 Kg	Unité

(*) Sur demande



OPTIM STONE

FIGURES DÉCORATIVES





MOAI BÉTON -1

Code	Ean Code	Mesures	Poids/Un. (Approx.)	Un./Palette (Approx.)	Un. Min. De Vente
FIG-MOAI-1	8436588672100	65 cm	40 kg	Unité	Unité

(*) Sur demande



Nos figures MOAI sont des simulations des têtes de l'île de Pâques. Les figures ont l'air d'avoir été patinées par les intempéries. Une pièce singulière et unique.

MOAI BÉTON -2

Code	Ean Code	Mesures	Poids/Un. (Approx.)	Un./Palette (Approx.)	Un. Min. De Vente
FIG-MOAI-2	8436588672117	150 cm	170 kg	Unité	Unité

(*) Sur demande



Nos figures MOAI sont des simulations des têtes de l'île de Pâques. Les figures ont l'air d'avoir été patinées par les intempéries. Une pièce singulière et unique.

MOINE DROIT BÉTON -1

Code	Ean Code	Mesures	Poids/Un. (Approx.)	Un./Palette (Approx.)	Un. Min. De Vente
FIG-MOIND-1	8436588672124	60 cm	30 kg	Unité	Unité

(*) Sur demande



Notre figure MOINE DROIT, porte une sébile dans ses mains et symbolise la pratique bouddhiste de l'aumône. Un lien spirituel entre les moines et le peuple bouddhiste, fondé sur la croyance selon laquelle le fait de donner l'aumône aux moines bouddhistes, et donc de prendre soin de leurs besoins physiques, signifie qu'ils prennent soin des besoins spirituels de la communauté en retour.



MOINE ASSIS BÉTON -1

Code	Ean Code	Mesures	Poids/Un. (Approx.)	Un./Palette (Approx.)	Un. Min. De Vente
FIG-MOINS-1	8436588672131	60 cm	45 kg	Unité	Unité
(*) Sur demande					



Unité

Notre figure MOINE ASSIS tient une tasse de thé dans ses mains, dans une attitude d'harmonie, de respect et de tranquillité. Les moines zen boivent du thé pour rester éveillés pendant leurs méditations. Cette figurine apportera paix et ambiance zen à l'espace extérieur où elle sera placée.

LANTERNE ZEN YUKIMI GATA BÉTON -1

Code	Ean Code	Mesures	Poids/Un. (Approx.)	Un./Palette (Approx.)	Un. Min. De Vente
FIG-LANTERN-1	8436588672148	70 cm	50 kg	Unité	Unité
(*) Sur demande					



Unité

Notre figure LANTERNE ZEN YUKIMI GATA, (lanternes de neige) ont un sommet large, idéal pour que la neige s'y dépose, ce qui les rend particulièrement belles en hiver. Étaient traditionnellement utilisés dans les temples et les sanctuaires du Japon.



YOGA LOTO BÉTON -1

Code	Ean Code	Mesures	Poids/Un. (Approx.)	Un./Palette (Approx.)	Un. Min. De Vente
FIG-YLOTO-1	8436588672155	80 cm	70 kg	Unité	Unité
(*) Sur demande					



Unité

Notre figure YOGA LOTO, avec les mains posées sur les genoux, est un symbole d'harmonie et de pleine conscience. Cette figure est très inspirante pour la pratique de la méditation et pour apporter le calme et la paix. Originaire de l'Inde, le yoga est une discipline traditionnelle qui améliore la stabilité physique, mentale et spirituelle.



YOGA NAMASTE BÉTON -1



Code	Ean Code	Mesures	Poids/Un. (Approx.)	Un./Palette (Approx.)	Un. Min. De Vente
FIG-YNAMASTE-1	8436588672162	80 cm	48 kg	Unité	Unité
(*) Sur demande					



Unité

Notre figure YOGA NAMASTE, avec les mains jointes au-dessus de la tête, symbolise la concentration. Cette figure est très inspirante pour la pratique de la méditation et pour apporter le calme et la paix. Originaire de l'Inde, le yoga est une discipline traditionnelle qui améliore la stabilité physique, mentale et spirituelle.

YOGA MELANCOLIE BÉTON-1

Code	Ean Code	Mesures	Poids/Un. (Approx.)	Un./Palette (Approx.)	Un. Min. De Vente
FIG-YMELANCOL-1	8436588672179	50 cm	15 kg	Unité	Unité
(*) Sur demande					



Unité

Notre figure YOGA MÉLANCOLIE symbolise la force que la tristesse nous apporte. Selon la philosophie bouddhiste, la douleur est une force. Sans cette douleur, nous ne pourrions jamais n'avancer sur notre chemin. La tristesse nous aide à définir et apprécier ce que nous avons. Elle a le potentiel de nous rendre résilients.

CONSIGNE PALETTES :

MARQUAGE PALETTES CONSIGNÉES :

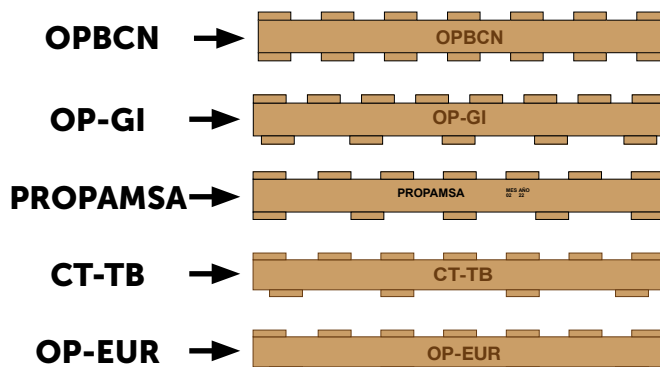

PRESTATAIRE SERVICE PALETTES CONSIGNÉES EPALIA

Assistance e-pallet. Notre équipe dédiée se tient à votre disposition.

assistance@e-palett.com

0 810 512 202

Pour déclarer que vous avez des palettes à récupérer :

e-palett : www.e-palett.com



Délai de collecte
sous **21 jours**
calendaires

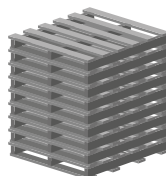

Quantité minimum de **50 palettes**
si vous n'avez qu'un seul
fournisseur de palettes consignées
collectées par Epalia

COLLECTE

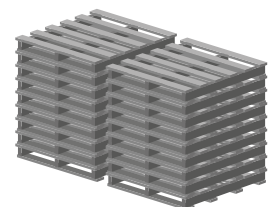

Quantité minimum
de **100 palettes** si vous
en avez plusieurs.

CONTACTS

Jean-Paul Salvi

Portable: 06 23 58 13 45
jsalvi@optimbeton.com

Hervé Robert

Portable: 06 73 48 59 47
hrobert@optimbeton.com

Christelle Gargallo

Tel. 05 34 01 06 17
Fax. 05 61 67 53 37
info@scgm-sarl.com



www.optimbeton.com



Ctra. Riudellots-Cassà, Km 3,8
17459 CAMPLLONG (GIRONA) (Espagne)
Tel. 0034 972 47 88 33
info@optimbeton.com
www.optimbeton.com

Type: Latitude Longueur
GD 41.897842 2.820346
GMS N 41° 53' 52.231" E 2° 49' 13.245"

